



Impressa F7

Fully Automatic
Coffee & Espresso Center
with Clearyl Water Care System

Operating Instructions
and Warranty

Customer Service 1-800-220-5701

IMPORTANT SAFEGUARDS

When using electrical appliances, basic safety precautions should always be followed, including the following:

1. Read all instructions.
2. Do not touch hot surfaces. Use handles or knobs.
3. To protect against fire, electric shock and personal injury, do not immerse cord, plugs or appliance in water or other liquids.
4. Close supervision is necessary when any appliance is used by or near children.
5. Unplug from outlet when not in use and before cleaning. Allow it to cool before putting on or taking off parts, and before cleaning the appliance.
6. Do not operate any appliance with a damaged cord or plug or after the appliance malfunctions, or has been damaged in any manner. Return appliance to the nearest authorized service facility for examination, repair or adjustment.
7. The use of accessory attachments not recommended by the appliance manufacturer may result in fire, electric shock, or personal injury.
8. Do not use outdoors.
9. Do not let the cord hang over the edge of a table or counter, or touch hot surfaces.
10. Do not place on or near a hot gas or electric burner, or in a heated oven.
11. Always attach plug to appliance first, then plug cord into

wall outlet. To disconnect, turn any control to "off" then remove plug from wall outlet.

12. Do not use appliance for other than intended use.
13. Use extreme caution when disposing hot steam.
14. For household use only.

SAVE THESE INSTRUCTIONS SPECIAL CORD SET INSTRUCTIONS

Regarding your cord set:

- A. A short power-supply cord (or detachable power-supply cord) is to be provided to reduce risks resulting from becoming entangled in or tripping over a longer cord.
- B. Longer detachable power-supply or extension cords are available and may be used if care is exercised in their use.
- C. If a long detachable power-supply cord or extension cord is used,
 - 1) The marked electrical rating of the detachable power-supply cord or extension cord should be at least as great as the electrical rating of the appliance,
 - 2) If the appliance is of the grounded type, the extension cord should be a rounding type 3-wire cord, and
 - 3) The longer cord should be arranged so that it will not drape over the counter-top or table-top where it can be pulled on by children or tripped over.

D. This appliance has a polarized plug (one blade is wider than the other). As a safety feature, this plug will fit in a polarized outlet only one way. If the plug does not fit fully in the outlet, reverse the plug. If it still does not fit, contact a qualified electrician. Do not attempt to defeat this safety feature.

CAUTION

This appliance is for household use. Any servicing other than cleaning and user maintenance should be performed by an authorized service representative.

- Do not immerse base in water or try to disassemble.
- To reduce the risk of fire or electric shock, do not remove the base. No user serviceable parts inside. Repair should be done by authorized service personnel only.
- Check voltage to be sure that the voltage indicated on the name plate agrees with your voltage.
- Never use warm or hot water to fill the water container! Use cold water only!
- Keep your hands and the cord away from hot parts of the appliance during operation.
- Never clean with scouring powders or hard implements.

JURA-CAPRESSO

Jura was founded in 1931 in Switzerland. Capresso was founded in 1994 in the USA. Both companies have joined forces in the US to bring you the finest Fully Automatic Coffee Centers available anywhere. With innovative and user-friendly features, high quality materials, clear instructions and superb customer service, we are sure you will experience the best coffee, espresso, cappuccino or latte you have ever had. We hope you will enjoy your new Fully Automatic Coffee Center and will recommend it to your friends. For more information about our products visit our website www.capresso.com.

Michael Kramm, President

Customer Service

1-800-220-5701

Mon-Thu 9AM – 9PM • Fri 9AM – 8PM • Sat 9AM – 5PM

Eastern Standard Time.

email: contact@capresso.com

Jura-Capresso LLC.

81 Ruckman Road, Closter, NJ 07624

201-767-3999 • Fax: 201-767-9684

Website: www.capresso.com

Fig. 1

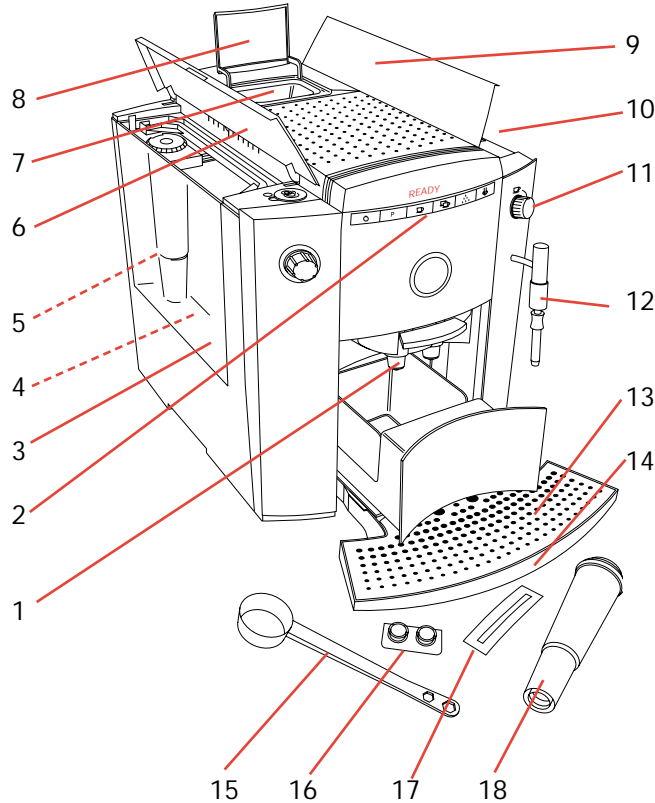

1. Height-Adjustable Coffee Spout
2. Operating Buttons (See Fig. 3)
3. Removable Water Tank
4. Low Water Flotation Device (See Fig. 7.4)
5. Clearyl Water Care Cartridge*
6. Lid for Water Tank
7. Ground Coffee Funnel
8. Auto-Lid for Ground Coffee Funnel
9. Lid for Bean Container
10. Bean Container (See Fig. 5)
11. Steam/Water Selector (See Fig. 4)
12. Dual Frother Plus
13. Stainless Steel Removable Grid
14. Removable Drawer
15. Measuring Scoop
16. Two Cleaning Tablets (white)
17. Water Hardness Indicator Strip
18. Clearyl Water Cartridge (unpacked)

Fig. 2

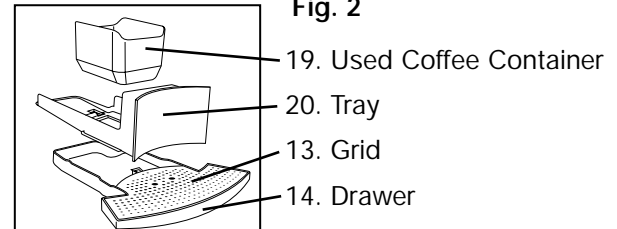

* Attention: The Water Filter Cartridge should be in a pouch.
If your machine comes with the cartridge installed, it is not a new machine!
Call customer service 1-800-220-5710.

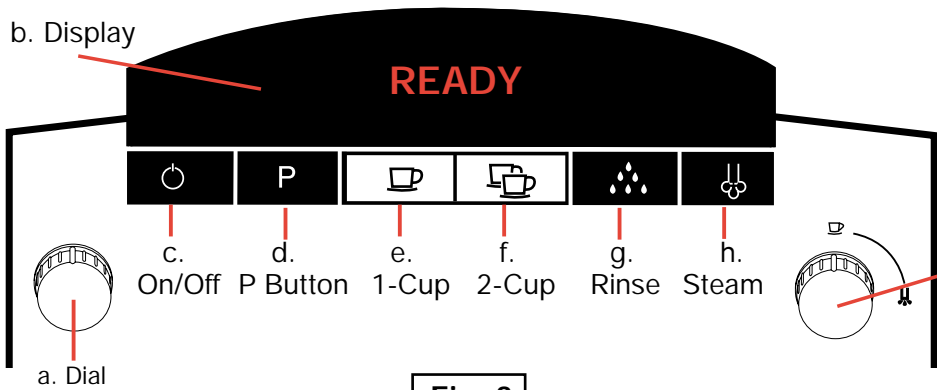

Fig. 3

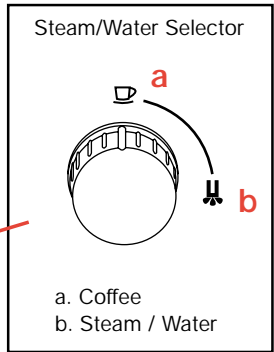

Fig. 4

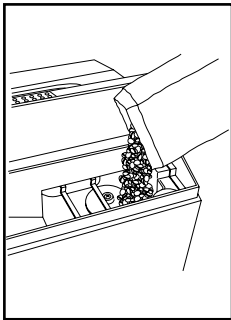

Fig. 5

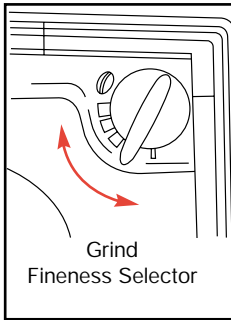

Fig. 6

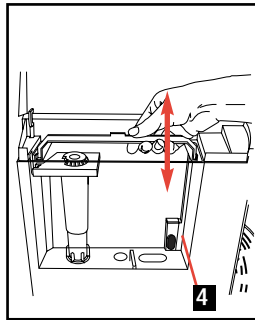

Fig. 7



Fig. 8

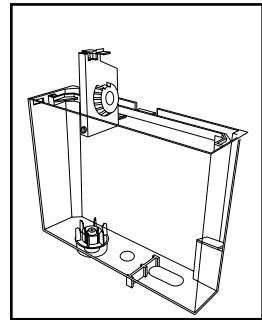

Fig. 9

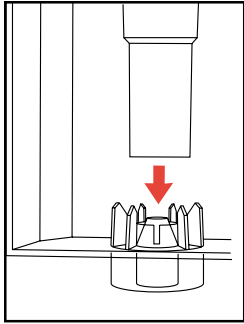

Fig. 10

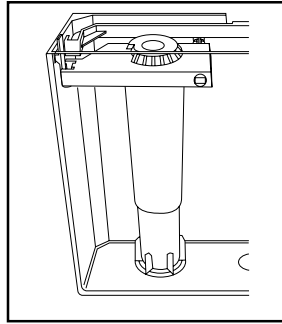

Fig. 11

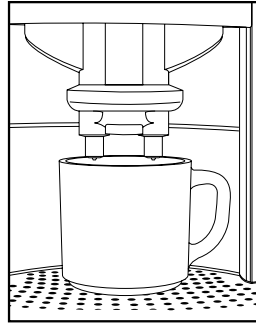

Fig. 12

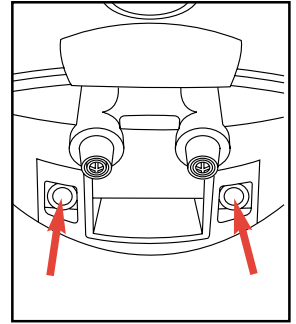
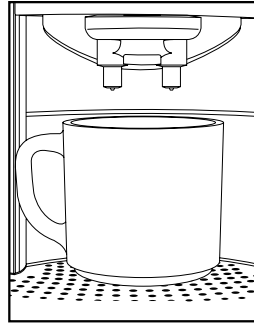

Fig. 12a

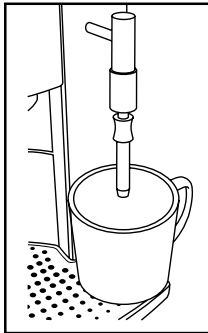

Fig. 13

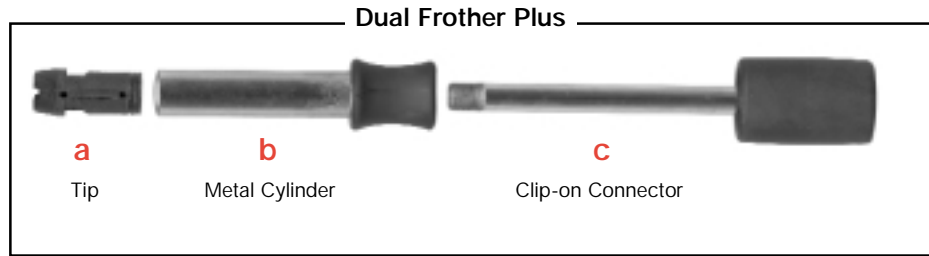

Fig. 14

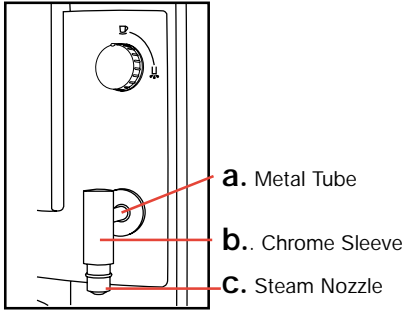

Fig. 15

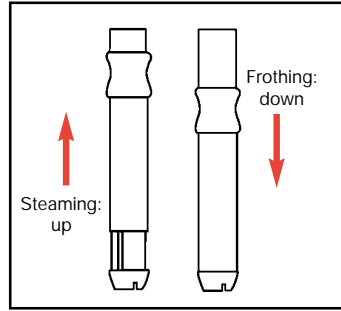

Fig. 16

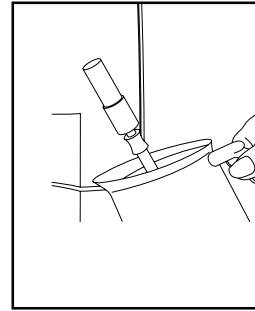

Fig. 17

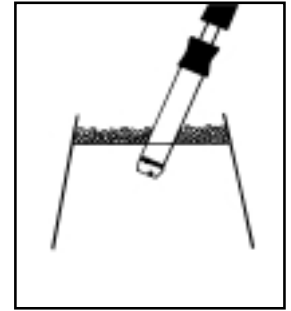

Fig. 18

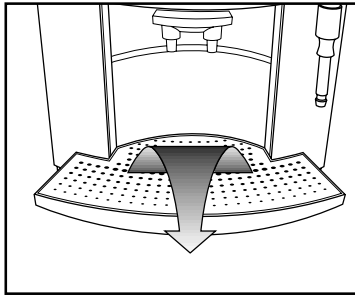

Fig. 19

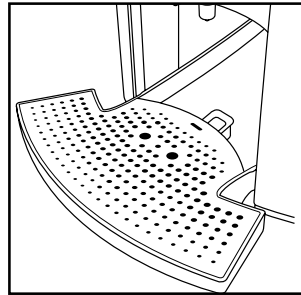

Fig. 20

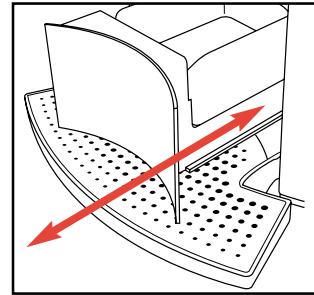

Fig. 21

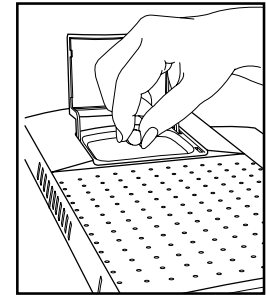

Fig. 22

Table of Contents

	Page
Important Safeguards.....	2
Jura-Capresso / Address Information.....	3
Illustrations.....	4-7
1. Product Registration.....	9
2. Operating Instructions / Customer Service.....	9
3. WELCOME TO THE IMPRESSA F7	9
a. "Crema Coffee" and Pressure Brewing	9
b. Different Coffee Drinks	10
c. Coffee Facts.....	10
4. Please Don't / Please Do	10
5. Factory Settings	11
6. PREPARING MACHINE FOR THE FIRST TIME	11
7. Adding Coffee Beans	12
8. Adjusting the Grinder	12
9. DAILY PREPARATION	12
10. Grinding and Brewing.....	12
a. Selecting Cup Size and Strength.....	12
11. Using Pre-Ground Coffee.....	13
12. Using Hot Water	13
13. FROTHING AND STEAMING	14
14. Heating and Frothing Milk	14
15. Cleaning the Dual Frother Plus	15
16. CLEARYL WATER CARTRIDGE	15
a. Installing and Activating the Clearyl Cartridge	16
b. Replacing the Clearyl Cartridge.....	16
17. Adjusting the Water Hardness.....	17
18. PROGRAMMING	17
a. Aroma	18
b. Temperature	18
c. Setting Time and Unit On	18
d. Auto Shut-Off	18
e. Cups Made.....	19
f. Language Selection	19
g. Display (OZ. or ML.; AM/PM or 24 HRS).....	19
19. CARE AND MAINTENANCE	19
a. Fill Water	19
b. Empty Tray / Empty Grounds.....	19
c. Fill Beans.....	19
d. Stones and Beans.....	20
e. General Cleaning Instructions.....	20
f. Emptying System Before Transport	20
20. AUTOMATIC CLEANING CYCLES	20
a. Rinsing	20
b. Cleaning with Special Tablet.....	20
c. Decalcifying Procedure	21
21. Tips for Better Coffee	22
22. SUPPLIES	22
23. frothXpress Plus System (sold separately).....	23
24. Troubleshooting.....	23
25. WARRANTY	24

1. PRODUCT REGISTRATION

Please read the enclosed product registration form now. Fill it out and mail or fax it to us within two weeks after purchasing your machine or register online through our website: www.cappresso.com. **Important:** This registration is part of your warranty (chapter 24).

2. OPERATING INSTRUCTIONS / CUSTOMER SERVICE

Thank you for choosing this Jura-Cappresso product.

- Please study these **Operating Instructions** carefully before using your new machine. We highly recommend viewing the enclosed **video**.
- Also included is a **Quick Reference Guide**. Keep it next to your machine.
- For further information please call our **TOLL FREE number: 1-800-220-5701, Mon-Fri 9AM – 9PM & Sat 9AM – 5PM Eastern Standard Time**. If you call at any other time please leave a message including your telephone number and a time you can be reached. You can send us a **FAX at: 201-767-9684** or **EMAIL us at contact@cappresso.com**.

3. WELCOME TO THE IMPRESSA F7

This fully automatic coffee center is completely programmable and extremely user friendly. Your Impressa F7 can prepare one or two cups of crema coffee at a time. The two-step pressure brewing system – well known in commercial applications – was adapted and refined by Jura coffee specialists and is the trademark of each Jura-Cappresso coffee center. This Pre-Brew Aroma-System ensures optimal coffee extraction and will finish every cup with a rich layer of "crema" – proof for perfectly pres-

sure brewed coffee. Just press one of the two cup buttons and your Impressa F7 will grind, tamp and brew your personal cup of coffee. The integrated solid steel conical burr grinder grinds beans to the preferred fineness. A separate funnel lets you use pre-ground coffee. All coffee, water and steam functions are programmable to your own personal taste. Make any size cup of coffee between 1 and 16 oz. The Dual Frother Plus* lets you froth and steam milk for delicious cappuccinos and lattes. The frother will deliver unlimited amounts of steam. The stainless steel lined ThermoBlock prevents water from coming in contact with aluminum and allows you to brew coffee immediately after frothing (no purging). The hot water function lets you prepare tea and other beverages in seconds. All important functions such as water level, bean container, used coffee container and water filter are monitored automatically. You can program the machine to turn itself on and off, change the language and check how many cups of coffee you made.

The F7 has a beautiful symmetrical design with a heavy-duty die-cast coffee spout, a stainless steel grid and elegant cup illumination. Enjoy your Impressa F7!

* The frothXpress Plus, an automatic frothing device, is separately available (chapter 23). For details on the frothXpress Plus accessory see video.

3a. "CREMA COFFEE" AND PRESSURE BREWING

According to the majority of coffee experts, grinding, tamping and brewing under high pressure is the ideal extracting process for maximum flavor and aroma. Your Jura-Cappresso automatic coffee center will always produce espresso and coffee with a thick, foamy layer called "crema." The crema traps the fine aro-

matics and the light gaseous flavors that register on the palate. The high pressure and the short brewing time prevent the extraction of bitter oils and release less caffeine than any other brewing method. You will always make the absolute freshest and most aromatic cup of coffee. This is the reason why many European restaurants and hotels serve only fresh pressured brewed coffee. Experiment with your new machine and prepare yourself the best and most enjoyable cup of coffee!

3b. DIFFERENT COFFEE DRINKS

Here are some guidelines for the most popular coffee drinks:

- Ristretto: 1/2 to 1 oz. of coffee. Sweeten to taste
- Espresso: 1 to 2 oz. coffee. Sweeten to taste
- Double Shot: 3 to 4 oz. of coffee. Sweeten to taste
- Crema Coffee: 5 to 8 oz. of coffee
- Cappuccino: Espresso plus 3 to 4 oz. of hot frothed milk.
- Latte: Espresso plus 3-5 oz. steamed milk with little or no froth.
- Café Mocha: Make Espresso then add chocolate syrup to the milk before frothing/steaming.

Experiment with the size of your milk based drinks. For stronger coffee taste add more coffee, for more milk taste add more frothed milk.

3c. COFFEE FACTS

- **Caffeine** is tasteless. A "strong" coffee or espresso is mostly the result of the amount of coffee in relation to the amount of water. The longer a bean is roasted, the less caffeine it has.
- **Arabica and Robusta** are two genetically different kinds of beans. "Arabica" beans have more flavor and a little less caffeine than "Robusta" beans which are mostly used in lower priced coffees and instant coffees.

- **Espresso** is not a bean, it's the way the coffee is roasted and prepared. Typical US espresso roasts result in darker beans with an oily surface. European espresso roasts are medium brown with no or very little oils on the surface.

Please note: Dark, oily beans: see chapter 7.

4. PLEASE, DON'T... (or you void your warranty protection):

- Never pull out the drawer during the brewing process.
- Never fill instant coffee into the bean container or ground coffee funnel; it can damage the brewing chamber.
- Never fill sugar coated coffee beans into the bean container.
- Never fill frozen beans into the bean container. If you store beans in the freezer, let them thaw 3 to 4 hours before filling them into the bean container.
- Never fill anything other than coffee beans into the bean container (no chocolate, rice, nuts, spices, etc.)
- Never fill anything but fresh, cold clean water into the water container, except when decalcifying (chapter 20b).
- Never use mineral or carbonated water. You can use tap water, spring water, distilled water and reverse osmosis water.
- Never repair or open the machine yourself. All repairs should be performed only by an authorized service center.

PLEASE, DO...

- Fill water tank with fresh, cold water only.
- Remove any foreign particles (small stones) from coffee beans.
- Let frozen beans thaw 3 to 4 hours before pouring them into the bean container.

All Display Messages Are Shown in RED

5. FACTORY SETTINGS

Each machine leaves the factory with the following settings:

Filter – (not installed)
Hardness Level 2
Aroma ROBUST
Temperature HIGH
Time Not Set
Unit On Not Set
Auto Off 2 HRS
Cups Made –
Language English
Display OZ and AM PM

The Dial (Fig. 3a) is set to **4 OZ.** for coffee and hot water and **60 SEC** for steam.

CUP ILLUMINATION (Fig. 12a)

The cup illumination adds a dramatic touch to brewing coffee. Providing the machine is plugged in, you can activate the cup illumination for 1 minute by pressing any button.

6. PREPARING THE MACHINE FOR THE FIRST TIME

- Make sure all accessories, literature and any other items are removed from the machine and the water tank.
- Make sure the Clearyl Water Filter is NOT installed!
- Make sure the machine sits on an even, flat surface and the drawer, tray and used coffee container are inserted (Fig 2).
- Plug-in machine.

- Turn the machine on by pressing the ON/OFF button (Fig. 3c). The display shows **FILL WATER**. (If you have already filled the water tank, the message **OPEN TAP** will be displayed).
- Remove water tank, fill with fresh, cold water and replace. The display shows **OPEN TAP**.

The following procedure is only necessary when setting up the machine for the first time and after the procedure "Emptying System Before Transport" (chapter 19f).

- Place a cup underneath the frother (Fig. 13) and turn the Steam/Water Selector to the Steam /Water symbol Fig. 4b). **SYSTEM FILLING**. The machine will pump some water through the frother and stop automatically. **CLOSE TAP**. Turn the Steam/Water Selector back to the cup symbol. **SYSTEM FILLING. HEATING. PRESS RINSE**. Place a cup underneath the Coffee Spout (Fig. 12) and press the Rinse Button (Fig. 3g.) The machine will pump a bit of hot water through the coffee spouts and will stop automatically. **READY. You can only brew coffee when the display shows READY**.
 - Open the bean container lid (Fig. 1, 9) and fill with beans (Fig. 5). For details see chapter 7.
 - Place an empty cup (at least 8 oz.) under the coffee spouts.
 - Push the Dial (Fig. 3a). The Dial illuminates and the display shows the cup size **4 OZ.**
 - Push and hold the 1-Cup button until the display reads **STRONG**. The F7 starts grinding and will start brewing. Initially, the chamber may not fill properly with ground coffee. The machine will start brewing, then interrupt and the display will show **FILL BEANS**. Push the 1-Cup button again. Discard the first 2 cups of coffee. Your next cup will be perfect.
- Please note:** If coffee only comes out of one spout, move the

spout up and down a few times to clear the internal flow. You are now ready to make coffee.

7. ADDING COFFEE BEANS

- Open the bean container lid (Fig. 1, 9), fill with beans (Fig. 5). The container holds approx. 220 grams (8 oz.). Close the lid.
- Frozen Beans:** Thaw 3 to 4 hours before adding to bean container. This prevents moisture from seeping into the grinder.

Sugar Coated Beans: DO NOT fill sugar coated beans into the bean container. The sugars will stick to the burrs and clog the flow of ground coffee. Have your local coffee store grind the sugar coated beans and use as described in chapter 11.

Using Oily Beans: Beans with an oily surface tend to stick together. This may prevent a continuous flow of beans from the bean container into the burrs. As a result the grinder does not grind enough coffee and you might get weak or no coffee at all. Stir the beans in the bean container just before grinding. Alternatively, you can also pour the beans in an open bowl and let them sit for about 5 hours. The oils will evaporate (this will not change the taste of your coffee). Then fill the beans into the bean grinder. Now beans will feed into the burrs more easily.

8. ADJUSTING THE GRINDER

You can adjust the grinder to the roast of your coffee. We recommend the following:

Light roast: use a finer adjustment.

Dark roast: use a coarser adjustment.

- Open the lid of the bean container.
- While the grinder is running turn the grind selector switch to the desired position (Fig. 6).

- The smaller the dots, the finer the grind.
- The bigger the dots, the coarser the grind.

Important: The grinding grade can only be adjusted while the grinder is actually grinding.

9. DAILY PREPARATION

ON/OFF Button – HEATING – RINSE – READY

We recommend filling the water container every morning with fresh, cold water. This will enhance the taste of your coffee.

- Push and hold On/Off button until the display turns on. If your machine is cold the display shows **HEATING**. After approx. 2 minutes the display shows **RINSE**.
- Press the Rinse Button (Fig. 3g). Hot water will warm up all internal parts and pump through the coffee spouts. The water will be caught in the drawer underneath. The rinse cycle stops by itself and the display reads: **READY**. You are now ready to make coffee.

10. GRINDING AND BREWING

The Impressa F7 uses a 2-step brewing process (Pre-Brew Aroma System). First, it moistens the ground coffee (pre-brew phase), pauses for a few seconds, and then starts the brewing process.

- Adjust the height of the coffee spout to your cup size (Fig. 12) and place one or two cups underneath the coffee spouts.

10a. SELECTING CUP SIZE AND STRENGTH

Cup Size 1 OZ. to 8 OZ; max: 16 oz.

- Push the Dial. It will illuminate and the display will show the cup size in oz, e.g. **4 OZ**.
- Turn the dial to select any cup size between **1 OZ.** and **8 OZ.** Your machine will always remember the last setting. After a few seconds the display will change back to **READY**.

- When using the **2-Cup** button the machine will automatically double the selected amount of coffee.

Coffee Strength MILD – NORMAL - STRONG

Push the 1-Cup button once, the display shows **MILD**.

Push the 1-Cup button twice, the display shows **NORMAL**.

Push the 1-Cup button three times, the display shows **STRONG**.

You can also push and hold the 1-Cup button until the desired strength is shown in the display.

Grinding times (approx.)

MILD 6 to 7 seconds.

NORMAL ... 7.5 to 8.5 seconds.

STRONG..... 9 to 10 seconds.

AROMA-setting "**STANDARD**" has the shorter grinding times.

AROMA-setting "**ROBUST**" has the longer grinding times.

When using the 2-Cup button the grinder will always grind between 9 and 10 seconds. For AROMA setting see chapter 18a.

Please note:

When using the 1-Cup button, the display will first show the strength setting. When the pre-brew cycle starts, it will show the actual cup size. At this time you can still change the cup size by turning the Dial.

When using the 2-Cup button, the display will first show **2 CUPS**. When the pre-brew cycle starts, the display shows the cup size for one cup. At this time you can still change the cup-size by turning the Dial.

Please note: After the pre-brew cycle you can always stop the brewing process by pushing the 1-Cup or 2-Cup button. This will not affect your cup size setting for the next brew cycle.

Important: Never try to pull out the tray while the machine is

grinding, brewing, or discarding the used coffee. Always wait until the display shows **READY**.

11. USING PRE-GROUND COFFEE

You can also use pre-ground coffee, bypassing the grinder. This comes in handy if someone requests decaf, sugar coated or flavored coffee.

- Open the lid for the ground coffee funnel (Fig. 1.8). The display shows **FILL POWDER**. Fill the funnel with one or two scoops of ground coffee.

Important: Do NOT fill this funnel with instant coffee and do not use more than two level scoops of coffee.

- Close the funnel lid. The F7 will tamp the ground coffee. **SELECT CUP BUTTON.**

- Push the 1-Cup or 2-Cup button. The display shows the cup size. As long as the Dial (Fig. 3a) is illuminated, you can still change the cup size.

Please note: If you accidentally open the funnel lid, just close it again. The display shows **NOT ENOUGH POWDER** and then returns to **READY**.

Please note: After use of sugar coated or flavored coffee through the pre-ground coffee funnel you may experience some flavor transfer when switching back to your regular coffee.

- Push the Rinse Button (Fig. 3g) The display shows **RINSING**. The F7 performs a rinse cycle and returns to **READY**.

12. USING HOT WATER

READY – 1 OZ. to 16 OZ. – CLOSE TAP - READY

The hot water feature allows you to make a cup of tea, soup or add hot water to your coffee, making it less strong.

- Place a cup underneath the frother (Fig. 13).
- Turn the Steam/Water Selector to the water symbol (Fig. 4b). Hot water will push through the frother. The display shows the amount of hot water. You can change it from 1 to 16 oz. by turning the Dial (Fig. 3a). The machine remembers the last setting. When the water flow stops, display shows **CLOSE TAP**.
- Turn the Steam/Water Selector back to the cup symbol. **READY**.
Please note: You can always stop the flow of hot water by turning the dial to the cup symbol.

13. FROTHING and STEAMING

The steam function can be used to heat up any liquid and to steam and froth milk.

Steaming Position:

The Frother's metal cylinder is in the UP position (Fig. 16). In the steaming position hot steam is injected into the milk (or any other liquid) without creating a frothy layer on top.

Typically a Latte has steamed milk with no froth.

Frothing Position:

The Frother's metal cylinder is in the DOWN position (Fig. 16). In the frothing position hot steam and air is injected into the milk creating warm milk and a firm layer of tiny froth bubbles.

14. HEATING AND FROTHING MILK

READY – HEATING - STEAM READY - 60 SEC - CLOSE TAP

- Push the Steam button (Fig. 3h). Display shows **HEATING**.
- Add cold milk to a pitcher or a cup.
- After 15 to 30 seconds the display shows **STEAM READY**.
- Immerse the tip of the frother into the milk (Fig. 17, 18) and turn the Selector to the Steam/Water Symbol (Fig. 4b). Hot

- steam will be injected into the milk. The display shows how long steam will be forced through the frother, **60 SEC**.
- At this time you can change the steam output from 3 and 120 seconds. The machine will remember your last setting. When the selected steam time is up, the display shows **CLOSE TAP**.
 - Turn the Selector to the cup symbol (Fig. 4a).

Please note: You can always stop the steam output by turning the Steam/Water Selector to the cup symbol.

Please note: When you stop the steam output the display will show **READY**. If you want to repeat the steam function, first push the steam button (Fig. 3h). Since the Thermoblock is still very hot, **STEAM READY** will appear instantly. If you do not push the steam button first, the F7 will start pumping hot water through the frother.

Please note: When you start steaming, some hot water will push out of the nozzle before the steam begins. When frothing a lot of milk this will not change the taste of your frothed milk. You can also release this small amount of hot water into the tray or into a separate container as follows:

- Turn the Steam/Water Selector to the Water Symbol for one second and then back to the Cup symbol. Now push the steam button (3h) and start frothing/steaming.

Tips for frothing (Cappuccino):

The tip of the frother should not touch the bottom of your pitcher. Start in the steaming position – cylinder "up" (Fig. 16) – for a few seconds. Then push the cylinder "down". Milk froth will build up. This way the froth on top of your milk is also warm. If the frothed milk is not warm enough, continue in the steaming position.

Steaming and frothing directly in your cappuccino cup:

With practice, you can steam and froth directly in your cappuccino cup. First steam and froth the milk, then add your espresso shot.

Please note: The less fat content the milk has the more froth will be created. Skim milk will produce the most froth and will let you taste more of the coffee. 1% and 2% milk will give you less froth. Regular whole milk (3% fat) will produce the least amount of froth. You can also use soy milk.

15. CLEANING THE DUAL FROTHER PLUS

Always keep the Dual Frother Plus clean and free of milk deposits. Clean immediately after use. Hardened milk particles will make it impossible to create milk froth.

Fast cleaning:

Display shows **READY**. Place a cup underneath the frother (Fig. 13) and turn the Steam/Water Selector to the water symbol. Let hot water run through the frother for about 3 seconds and then stop. This will flush out any small milk droplets.

Thorough cleaning of the Dual Frother parts:

- Remove the Dual Frother (Fig.14) from the Steam Nozzle (Fig. 15c).

Please note: The Dual Frother is tightly connected to the Steam Nozzle. First loosen the Clip-On Connector part (Fig. 14c) by turning it a few times, then push down to remove.

- Unscrew the black tip (Fig.14a) from the Clip-On Connector (Fig. 14c). You can use a coin to loosen the black tip.
- Soak all three parts in hot soapy water.
- Make sure that the two side holes and the channel of the black tip (Fig. 14a) are free of any milk deposits.

Cleaning the Steam Nozzle (Fig. 15c)

- Place a cup underneath the Steam Nozzle (the Dual Frother is off) and let a bit of hot water run through the Steam Nozzle.
Tip: If the steam nozzle is blocked by hardened milk, use a needle, toothpick or paper clip and loosen up the milk deposit. Then let some hot water pass through the Steam Nozzle.

Assembly of Frother Parts

- Make sure the Steam Nozzle is screwed onto the Metal Tube (Fig. 15a) finger tight.
- Assemble the Dual Frother and make sure that the tip is screwed onto the Connector finger tight (Fig 14a, c).
- Push the black Clip-on Connector (Fig.14c) firmly into the steam nozzle (the connector should sit flush with the chrome sleeve (Fig. 15b) so that the steam nozzle is no longer visible).
Please note: If the parts are not connected tightly it will not be possible to create the frothy foam on top of the milk.

16. CLEARYL WATER FILTER CARTRIDGE

The machine comes with one Water Filter Cartridge. This cartridge is specially made for use with the F7.

The cartridge:

- Reduces the water hardness up to 75%.
- Removes (if present) up to 85% chlorine, up to 90% lead, up to 95% copper and up to 67% aluminum.
- Cleans the water through an upward current principle (Fig. 8) just before the brewing cycle starts, ensuring freshly filtered water every time you make coffee.
- Eliminates decalcifying. When using the water filter cartridge, you never need to decalcify your machine.
- To reorder cartridges see chapter 22 "Supplies".

16a. INSTALLING & ACTIVATING THE CLEARYL WATER CARTRIDGE

Important: Never install the cartridge before or during "Preparing Machine For The First Time."

- Make sure the water tank is empty.
- Remove cartridge from its bag and rinse cartridge under water.
- Open water container lid and pull up the holder for the cartridge (Fig.9).
- Insert the cartridge with its tapered end down. Make sure it fits securely over the white mesh piece inside the water container. Push down gently (Fig.10).
- Close the holder for the cartridge so that it engages in the water tank (Fig.11).
- Fill the water tank with fresh cold water and replace.

You must activate the cartridge as follows:

1. Push and hold the P button (Fig. 3e). **FILTER –**
2. Push the Dial and the display shows **NO**
3. Turn the Dial until the display shows **YES**
4. Push Dial confirm. The display shows **INSERT / OPEN TAP**
5. Place a 20 oz. container underneath the frother.
6. Turn the Steam/Water Selector to the water symbol.

FILTER RINSING. For the next 90 seconds the machine will push water through the filter and through the frother. Do not interrupt this process. This activates the filter.

The machine will stop automatically.

7. **CLOSE TAP.** Turn the Water/Steam Dial back to the cup symbol. **HEATING. READY.**

Please note: As long as the filter is activated, the water hardness setting is automatically turned off.

16b. REPLACING THE CLEARYL WATER CARTRIDGE

The filter is monitored automatically. After approx. 75 liters of water (~2,500 oz.), the filter loses its effect. The display changes from **READY** to **CHANGE FILTER / READY**. You can still make coffee, but we recommend replacing the filter within one week!

Attention: The filter should be changed every 3 months if you use less than 75 liters of water. In this case, no message will appear in the display.

Important: Once the filter has lost its calcium suppressing abilities, calcium will build up inside the machine. Since the Water Hardness Selector is off, the machine will not remind you when to decalcify. This could clog and ruin your machine.

- Remove the old filter. The cartridge is environmentally friendly. Dispose it with your regular household trash.
- Make sure the water tank is empty.
- Remove the new cartridge from its bag.
- Open the water container lid and pull up the holder for the cartridge (Fig. 9).
- Insert the cartridge with its tapered end down. Make sure it fits securely over the white mesh piece inside the water container. Push down gently (Fig.10).
- Close the holder for the cartridge so that it engages in the water tank (Fig.11).
- Fill the water tank with fresh cold water and replace.
 1. Turn machine off. Push and hold the Rinse Button until the display shows **CHANGE FILTER / OPEN TAP**.
 2. Place a 20 oz. container underneath the frother.
 3. Turn the Steam/Water Selector to the water symbol.

FILTER RINSING.

For the next 90 seconds the machine will push water through

the filter and through the frother. Do not interrupt this process. This activates the filter. The machine will stop automatically.

4. **CLOSE TAP.** Turn the Water/Steam Dial back to the cup symbol. **HEATING. READY.**

17. ADJUSTING THE WATER HARDNESS

Water is heated inside the machine. With use, this leads to calcium deposits forming inside the machine. The display will remind you when it is time to perform a decalcifying cycle. The machine is set to level 2 (medium hard water). If you have harder water you need to set it to a higher level. If you have softer water you can set it to level 1. If you are not sure about the hardness of your water, ask your local water company for the "Water Hardness in Grains."

HARDNESS LEVEL 1: grains 2-9

HARDNESS LEVEL 2: grains 10-19

HARDNESS LEVEL 3: grains 20-29

HARDNESS LEVEL 4: grains 30+

You can also use the enclosed water hardness indicator strip to determine the water hardness:

- Insert the stick for one second into the water you want to use. Shake off any access water and wait for one minute.
- If all five fields of the test stick turn reddish, set the hardness level to 4. If four fields turn reddish, set the hardness level to 3. If three or less fields turn reddish, leave the level in position 2.
- If you use Spring Water you can set the hardness level to 1.

You can change the hardness settings as follows:

1. Push and hold the P button (Fig. 3d). **FILTER -**.
2. Turn the Rotary Dial until the display shows **HARDNESS**.
3. Push the Dial. **LEVEL 2.**

4. Turn the Dial to select from **1 2 3 4 -**.

5. Push the Dial to confirm your selection. **HARDNESS.**

6. Push the P button. **READY.**

Important: If you choose the selection "-" the water hardness monitor is turned off. In this case the machine will NOT remind you when it is time to decalcify. Turning off the monitor requires you to either use distilled water only or the Water Filter Cartridge (chapter 16a).

18. PROGRAMMING

Please note: As long as you are in programming mode, you cannot brew coffee.

- Push and hold the P button until the display shows **FILTER**. Turning the Dial clockwise the following functions will appear in the display:
HARDNESS
AROMA
TEMP.
TIME
UNIT ON
OFF AFT. HR
CUPS MADE
LANGUAGE
DISPLAY

To change functions the procedure is always the same:

1. Push and hold P button until display shows **FILTER**.
2. Turn Dial to the function you want to change or look up.
3. Push Dial.
4. Turn Dial until desired selection is displayed.
5. Push Dial to confirm selection.

6. Push the P button to get back to **READY**.

FILTER: See chapter 16a.

HARDNESS: See chapter 17.

18a. AROMA

1. Push and hold P button until display shows **FILTER**.

2. Turn Dial to **AROMA**.

3. Push Dial: **ROBUST**.

4. Turn Dial to select from **STANDARD** or **ROBUST**.

5. Push Dial to confirm selection.

6. Push the P button to get back to **READY**.

In **ROBUST** the grinder will always grind approx. 1 second longer to increase the strength of your coffee.

18b. TEMPERATURE

1. Push and hold P button until display shows **FILTER**.

2. Turn Dial to **TEMP**.

3. Push Dial: **HIGH** Turn Dial to select from **NORMAL** or **HIGH**.

4. Push Dial to confirm selection.

5. Push the P button to get back to **READY**.

In **NORMAL** the temperature of the coffee is approx. 7° F lower than in **HIGH**.

18c. SETTING THE TIME and UNIT ON

You can program your F7 to turn on automatically at a preset time. First set the actual time, then set the **UNIT ON** time.

Please note: For Daylight Savings you have to reset the **TIME** function.

1. Push and hold P button until display shows **FILTER**.

2. Turn Dial to **TIME**.

3. Push Dial: **-- : --**

4. Turn Dial to select the hours. Push Dial to set.

5. Turn Dial to select the minutes. Push Dial to set: **TIME**

6. Turn the Dial: **UNIT ON**.

7. Turn Dial to select the hours. Push Dial to set.

8. Turn Dial to select the minutes. Push Dial to set: **UNIT ON**.

9. Push the P button to get back to **READY**.

Please note: if you do not want the machine to turn on at the pre-set time, set the **UNIT ON** time to **-- : --**.

18d. AUTO SHUT-OFF

1. Push and hold P button until display shows **FILTER**.

2. Turn Dial to: **OFF AFT HR**.

3. Push Dial: **2.0 HRS**.

4. Turn Dial to select from **-- HRS** to **9.0 HRS**.

5. Push Dial to confirm selection.

6. Push the P button to get back to **READY**.

In selection **-- HRS** the machine will not shut off automatically.

Please note: When the machine turns off, it will automatically run a hot water rinse cycle. The water will push through the coffee spouts and will be caught in the tray.

Recommendation:

- If you use the machine in the morning and then later in the day, set the auto-shut off between 0.5 HRS and 2.0 HRS.
- If you use the machine all day long set the auto shut off between 3.0 HRS to 5.0 HRS.
- If you make only one or two cups of coffee in the morning, set the machine to 0.5 HRS.

Important: Never turn the machine off immediately after you have made a cup of coffee. The automatic hot water rinse cycle works more effectively after the brewing chamber has cooled down.

18e. CUPS MADE

1. Push and hold P button until display shows **FILTER**.
2. Turn Dial to **CUPS MADE**.
3. Push Dial: The display shows the total number of cups brewed.
4. Push the 1-Cup or 2-Cup Buttons to display usage.
5. Open the Funnel Lid for 2 seconds to check how often this feature was used. Close the Funnel Lid.
6. Push the P button once or twice to get back to **READY**.

18f. LANGUAGE SELECTION

1. Push and hold P button until display shows **FILTER**.
2. Turn Dial to **LANGUAGE**.
3. Push Dial: **ENGLISH**.
4. Turn Dial to select from English, German, French, Italian Spanish, Portuguese, Dutch (NL)
5. Push Dial to confirm selection.
6. Push the P button to get back to **READY**.

18g. DISPLAY

Choose to display the cup size in Ounces (OZ) or Milliliters (ML).
30 ML equals 1 OZ.

1. Push and hold P button until display shows **FILTER**.
2. Turn Dial to **ML / OZ**.
3. Push Dial: **OZ**.
4. Turn Dial to select **ML** or **OZ**.
5. Push Dial to set selection.

Choose to display the time in AM PM or 24 hour mode.

6. Turn Dial to **24H / AM PM**.
7. Push Dial and turn to select **24H** or **AM/PM**.
8. Push the P button to get back to **READY**.

19. CARE AND MAINTENANCE

19a. FILL WATER

When the display shows **FILL WATER**, no more coffee can be made until you fill the water container. The water container will never be completely empty. The low water floatation device (Fig. 7.4) activates the **FILL WATER** indicator when there are about 10 oz. of water left.

- Remove water tank, rinse and fill with fresh water and replace.

19b. EMPTY GROUNDS

Used coffee grounds are collected in the used coffee container (Fig. 2.19). If the display shows **EMPTY GROUNDS** or **EMPTY TRAY**, no more coffee can be made until you empty the used coffee container.

- Carefully lift and remove drawer since there is water in it (Fig. 19).
The display shows **TRAY MISSING**.

Important: Do not unplug the machine while you are emptying the coffee grounds.

- Empty the used coffee container and the drawer.
- Push the drawer back into the machine (Fig. 20). The display still shows **TRAY MISSING**.
- Place the used coffee container on the tray and insert back into the machine (Fig. 21). The display shows **READY** and you may now continue brewing coffee.

19c. FILL BEANS

When the display shows **FILL BEANS**, open the bean container lid and add beans (Fig. 5).

Please note: The message **FILL BEANS** will disappear after making the next cup of coffee.

Attention: If the display shows **FILL BEANS** and there are

ample beans in the bean container, stir the beans so they flow into the grinder (chapter 7). We recommend cleaning the bean container from time to time with a dry cloth before you refill beans (please make sure the machine is turned off when cleaning).

19d. STONES AND BEANS

Every coffee specialty store will tell you that occasionally small stones can be found in with coffee beans. Small stones will be processed through the burr grinder without any harm (the stone will end up in the used coffee container).

However larger stones can block the burr grinder. The noise of the grinder will become very loud and the grinder will block. In this case please call our Customer Service: 1-800-220-5701.

Before Filling Beans into the Bean Container:

- Shake your bean bag thoroughly so that a stone will fall to the bottom of the bag.
- Before emptying the bean bag completely, check if there are any particles that look like stones and remove them.

19e. GENERAL CLEANING INSTRUCTIONS

Never use abrasive materials or chemicals to clean the machine.

- Clean the housing with a soft, damp cloth.
- Rinse water tank daily and fill with fresh, cold water.

19f. EMPTYING SYSTEM BEFORE TRANSPORT

This procedure is necessary to prevent water and frost damage in case you intend to transport your machine.

- Turn machine off.
- Place a cup underneath the frother.
- Push and hold the Steam Button until the display shows:

OPEN TAP. Turn the Steam/Water Selector to the water symbol. The machine will push a bit of water and steam into the cup underneath the frother.

- When display shows **CLOSE TAP** turn the Steam/Water Selector back to the cup symbol. The machine will automatically shut off.

Important: The next time you turn the machine on you must follow the instructions in chapter 6.

Please note: Before transporting the machine, make sure that the water tank is empty, the filter cartridge is removed (discard and use a new cartridge), the bean container is empty, the drawer and used coffee container are empty and clean.

Secure the lids of the water tank and the bean container with scotch tape. Pack entire machine with thick cushioning material on all sides to prevent damage.

20. AUTOMATIC CLEANING CYCLES

20a. RINSING

You can run an extra hot water rinse cycle as follows.

- **READY.** Push the Rinse button. **RINSING.** Hot water is dispersed through the coffee spouts and will stop automatically. **READY.**

20b. CLEANING WITH SPECIAL TABLET

The machine monitors how many coffees are brewed and how often the rinsing program is activated. After approx. 200 coffees the display will show **CLEAN / READY.**

This cleaning program will remove oil build-ups in the brewing chamber. The cleaning program takes about 15 minutes.

Please note: You can continue making coffee, however we highly recommend that you clean the machine as described

below within the next few days. Please use one white cleaning tablet (enclosed). The machine comes with a pack of 2 tablets. To re-order cleaning tablets see chapter 22.

Important: Once the cleaning program has started do not interrupt the procedure.

1. Make sure the machine is on and the water tank is full.
2. Push the Rinse button. The display shows **EMPTY TRAY**.
3. Remove and empty the drawer and used coffee container and replace complete assembly (Fig. 21) **TRAY MISSING**.

Important: Even if the drawer and the used coffee container are empty, you still need to remove the drawer for approx. 20 seconds and then replace it. The display shows **PRESS RINSE**.

4. Place a 12 oz. container under the coffee spouts.
5. Push the Rinse button. The display shows **CLEANING**.
After a moment the display shows **ADD TABLET**.
6. Open the ground coffee lid and drop in one white cleaning tablet (Fig. 22) and close lid. **PRESS RINSE**. The F7 comes with two tablets. To order more tablets see chapter 22.
7. Push the Rinse button. The display shows **CLEANING**.
The cleaning program will dispense hot foamy water in intervals through the coffee spouts.
8. When finished, the display shows **EMPTY TRAY**.
9. Lift and remove the drawer. Empty the used coffee container and drawer and replace. The display shows **READY** indicating the machine is now ready to brew coffee again.

Attention: You can run a tablet cleaning cycle at anytime even if the machine does not prompt you,

- **READY**. Push and hold the Rinse button until display shows

EMPTY TRAY.

- Continue with step 3 above.

20c. DECALCIFYING PROCEDURE

The machine has an integrated decalcifying program. When the display shows **DESCALE / READY** it is time to decalcify the machine. You can still make coffee. However, it is highly recommended that you decalcify the machine within the next 3 to 4 days.

Please note: If you use the Clearyl water cartridge and the display shows **DESCALE / READY**, then your cartridge function is not activated. Follow the instructions in chapter 16a to program the Clearyl Cartridge function.

Important: The decalcifying program must not be interrupted.

DECALCIFYING AGENT: Only use our special decalcifying tablets. For supplies see chapter 22.

CAUTION: Never use vinegar or any other decalcifying agent. This might damage internal parts of the machine.

1. Push the Rinse button. The display shows **EMPTY TRAY**.
2. Remove and empty the drawer and used coffee container and replace complete assembly (Fig. 21).
Important: Even if the drawer and the used coffee container are empty, you still need to remove the tray for approx. 20 seconds and then replace it. The display shows **SOLVENT IN TANK / OPEN TAP**.
3. Make sure the water tank is empty. Completely dissolve two

of the light brown tablets in 16 oz. of water and pour this mixture into the water tank.

4. Replace water tank. Place a large container (at least 20 oz.) underneath the frother.

5. The displays still shows **SOLVENT IN TANK / OPEN TAP**. Turn the Steam/Water Selector to the water symbol. The machine will pump the mixture through the frother in intervals. During this procedure the display shows **DECALC.ON**. When this cycle is finished the display shows **CLOSE TAP**.
6. Turn the Steam/Water Selector back to the cup symbol. The display shows **DECALC.ON**. Now the machine pumps the mixture through the coffee spout into the drawer.
7. When this cycle is completed the display shows **EMPTY TRAY**. Remove the container from underneath the frother. Carefully lift and remove the drawer, empty and thoroughly rinse all parts and replace. The display shows **FILL WATER**.
8. Remove the water tank, rinse thoroughly, fill with cold fresh water and replace.
9. Place a large container (at least 20 oz.) underneath the frother. The display shows **OPEN TAP**.
10. Turn the Steam/Water Selector to the water symbol. The machine will pump hot water through the frother in intervals. During this procedure the display shows **DECALC.ON**. When this cycle is finished the display shows **CLOSE TAP**.
11. Turn the Steam/Water Selector back to the cup symbol. The display shows **DECALC.ON**. Now the machine pumps hot water through the coffee spout into the drawer.
12. When the cleaning cycle is completed the display shows **EMPTY TRAY**. Remove the container from underneath the frother. Carefully lift and remove the drawer, empty and thoroughly rinse all parts and replace. The display shows **HEATING** and then **PRESS RINSE**.
13. Push the Rinse Button. The machine will run a regular rinse

cycle and the display will show **READY**.

14. Clean front of machine and grid with a moist, soft cloth.
Attention: You can run a decalcifying cycle at anytime even if the machine does not prompt you.

- Turn the machine off. Push and hold the Rinse button until display shows **EMPTY TRAY**.
- Continue with step 2 above.

21. TIPS FOR BETTER COFFEE

Height adjustable coffee-spout

Adjust the height of the coffee-spout to the size of your cups.

Grinding

Please refer to chapter 8 "Adjusting the Grinder."

Pre-warm cups

You should warm cups in advance with hot water or steam.

The smaller the quantity of coffee, the more important it is to warm your cups.

Sugar and cream

Warmth is lost by stirring the contents of the cup. Adding milk or cream from the refrigerator considerably lowers the temperature of the coffee. You can preheat milk and cream with the frother.

22. SUPPLIES AND ACCESSORIES

The following supplies are necessary to keep your machine in good working order:

- Clearyl Water Filter Cartridge - Model #64533
- Special Cleaning Tablets (white tablets) - Model #62205
- Decalcifying tablets (light brown tablets) - Model #61848

Please note: You must use decalcifying tablets if you do not use the Clearyl cartridge.

All supplies are available through:

- The enclosed mail order form that came with your machine
- Our toll free line at 1-800-220-5701 or
- The Internet at www.cappresso.com.

23. FROTHXPRESS PLUS SYSTEM WITH MILK CONTAINER

If you prepare many Cappuccinos or Lattes at a time, we recommend the fast and precise frothXpress Plus System. The system replaces the Dual Frother Plus and allows you to fill cup after cup with the desired amount of hot milk and milk froth automatically. See video for details. Sold separately.

- frothXpress Plus System - Model #64342

24. TROUBLESHOOTING

A. NO COFFEE COMES OUT OF THE COFFEE SPOUT

Reason: Beans in bean container are not properly feeding into the grinder because they are stuck together.

Solution: Stir beans before grinding and while grinding turn the grinding selector to the coarsest setting. See chapter 7.

Reason : You used ground coffee in the ground coffee funnel. The ground coffee was too fine.

Solution: Use ground coffee which is ground somewhat coarser.

Reason : No water is transported through the system.

Solution: Remove water container and make sure that the connecting valve is free of any particles (like a coffee bean etc).

Reason: The ground coffee funnel or the internal brewing chamber is clogged.

Solution: Place a cup underneath the coffee spout. Push the Rinse button (Fig. 3g). **RINSING.** Repeat the process if necessary until the blocked coffee is pushed into the used coffee container.

B. THE DISPLAY READS "FILL WATER" BUT THERE IS ENOUGH WATER IN THE WATER TANK.

Reason: The low water floatation device (Fig. 7.4) is missing.

Solution: Within the water tank is a small compartment (like a mouse trap). Inside is a small black floatation device. On top is a small clear see-through plastic cover. This small plastic cover is missing and the floatation device is outside of the small compartment. Check if you can locate both pieces and put it back together. If you cannot find them, call 1-800-220-5701. We will send the pieces to you **FREE OF CHARGE.**

C. INSUFFICIENT FROTHED MILK PRODUCTION

Reason: Milk is initially not cold enough or your milk is not suited for thick frothing.

Solution: Make sure milk is cold. Use a different type of milk. Skim milk will produce the thickest and longest lasting froth. Whole milk will produce less thick froth. See chapter 14.

Reason: The components of the frother are not assembled properly, or the components are clogged with hardened milk, or one or more of the components is missing, or the steam nozzle is clogged.

Solution: (See chapter 15)

- a. Remove frother. Check that steam comes out of the steam nozzle. If not, use a needle and clear blockage from inside steam nozzle.
- b. Clean all other frother parts and assemble properly.
- c. If any parts are missing either call Customer Service at: 1-800-220-5701 or use the enclosed mail order form to order the missing part.

**D. GRINDER MAKES AN EXTREMELY LOUD NOISE;
NO BEANS ARE GROUND**

Reason: A stone is blocking the burr grinder.

Solution: Call customer service at: 1-800-220-5701.

**E. THE DRAWER (Fig. 19) DOESN'T PULL OUT OR DISPLAY
SHOWS MALFUNCTION 8**

Solution: Turn off and unplug machine. Wait a minute. Turn machine on and wait until it stops making any noise. Now try to pull out the drawer. If this does not work, try the above procedure again. If this does not work, call customer service.

25. WARRANTY

For Home Use: Limited One Year Warranty

For Non-Home Use: Limited Six Month Warranty

This warranty covers your new IMPRESSA E Series. This warranty is in effect for the period described above from the date of the first consumer purchase and is limited to the United States of America. This warranty covers all defects in materials or workmanship (parts and labor) including UPS ground transportation for both ways, if necessary.

This warranty does not cover:

- Any machine NOT distributed by JURA-CAPRESSO within the United States.
- Any machine not purchased from an Authorized Dealer.
- Damage caused by accident, abuse, negligence, misuse, improper operation or failure to follow instructions contained in this manual.
- Any service or alteration performed by an unauthorized person, company or association.

- Damage caused by neglecting and omitting cleaning and decalcifying cycles.
- Damage caused by use of instant coffee or any other ingredients not allowed in this product.

This warranty will be void if the Product Registration Card is not sent within two weeks after purchase date.

Other limitations and exclusions:

Any implied warranties including fitness for use and merchantability are limited in duration to the period of the express warranty set forth above and no person is authorized to assume for JURA-CAPRESSO any other liability in connection with the sale of the machine. JURA-CAPRESSO expressly disclaims liability for incidental and consequential damages caused by the machine. The terms "incidental damages" refer to the loss of the original purchasers time, loss of the use of the machine or other costs relating to the care and custody of the machine. The terms "consequential damages" refer to the cost of repairing or replacing other property which is damaged when this machine does not work properly. The remedies provided under this warranty are exclusive and in lieu of all others. This warranty gives you specific legal rights, and you may also have other rights which vary from state to state.